

IMPACT OF DAMAGES TO WELDED JOINTS IN BASES OF POWERED ROOF SUPPORTS ON THE OPERATIONAL SAFETY

SUMMARY

The location and variation range of the length of damaged welds was determined on the grounds of test results on the type and size of damages to welded joints in powered roof support bases destined for repair. In the analysis of the effort of components of roof supports modeled by means of the finite elements method the impact of the length of the damages to the welds on the maximal value of reduced stresses was estimated. Cases of symmetrical and asymmetrical load used on stand tests were discussed. Due to local plasticization of the base steel plates occurring in the course of the torsion test, elasticity and plasticity material properties were considered in the MES. Examples of designating the limit value of the length of the damaged weld at which the powered roof support maintains its operational safety were presented.

Keywords: hydraulic roof support, weld crack, operational safety

WPLYW USZKODZEŃ POŁĄCZEŃ SPAWANYCH W SPĄGNICACH NA BEZPIECZEŃSTWO UŻYTKOWANIA SEKCJI OBUDOWY ZMECHANIZOWANEJ

Na podstawie wyników badań dotyczących rodzaju i wielkości uszkodzeń połączeń spawanych w przeznaczonych do remontu spągnicach sekcji obudowy zmechanizowanej określono lokalizację i przedział zmienności długości uszkodzonej spoiny. Na podstawie analizy wyężenia elementu sekcji modelowanego metodą elementów skończonych wyznaczono wpływ długości uszkodzonej spoiny na maksymalną wartość naprężenia zredukowanego. Rozpatrzono przypadki symetrycznego i asymetrycznego podparcia sekcji, stosowane w badaniach stanowiskowych. Ze względu na lokalne uplastycznienia blach spągnicy, występujące przy próbie skręcania spągnic, uwzględniono sprężysto-plastyczne charakterystyki materiałowe rozpatrywanego modelu MES. Przedstawiono przykłady wyznaczania granicznej wartości długości uszkodzonej spoiny, przy której jest zachowane bezpieczeństwo użytkownika sekcji obudowy.

Słowa kluczowe: obudowa zmechanizowana, pęknięcie spoiny, bezpieczeństwo użytkownika

1. INTRODUCTION

In the course of the operation of powered roof supports damages to welds of all essential components occur to: roof bars, bases, caving shields. After the damage to the weld is detected, depending on its range and location, decision on further operation of the roof support component must be undertaken.

The crack in the weld, accompanied by permanent displacement of joint elements in the vicinity of hydraulic actuator seats or pivotal joint lugs may lead to the loss of operational functionality of the roof support due to uncontrolled changes in the mutual positioning of the roof support components. Such types of damage require instant replacement of the component. However, it should be emphasized that the replacement of basic components of the powered roof support operating in the long wall is a complex and expensive procedure, as it involves temporary suspension of mining extraction.

Apart from damages of welds that require immediate replacement of the component, there are also local cracks in welds or in steel plates within the thermal impact zone

which do not lead to the loss of operational functionality of the powered roof support. If the damages concern skin plates and do not affect the genuine material of the component braces, the operator of the powered roof support frequently undertakes a decision on allowing further operation of the component until the end of long wall run, and provided that additional safety measures are observed.

By means of the analysis of the types and size of damages to welds detected in bases destined for repair, the impact of the damages on the effort of the powered roof support was examined for external symmetrical load, as well as for asymmetrical load.

2. DAMAGES TO WELDED JOINTS OF BASES

Tests were carried out to identify the damages of welds occurring in essential components of powered roof supports (Jaszczuk *et al.* 2009). The source materials were derived from the documentation on technical overhaul of the powered roof support components destined for repair. The tests involved three component types marked as AX, BY and CY.

* Silesian University of Technology, Faculty of Mining and Geology

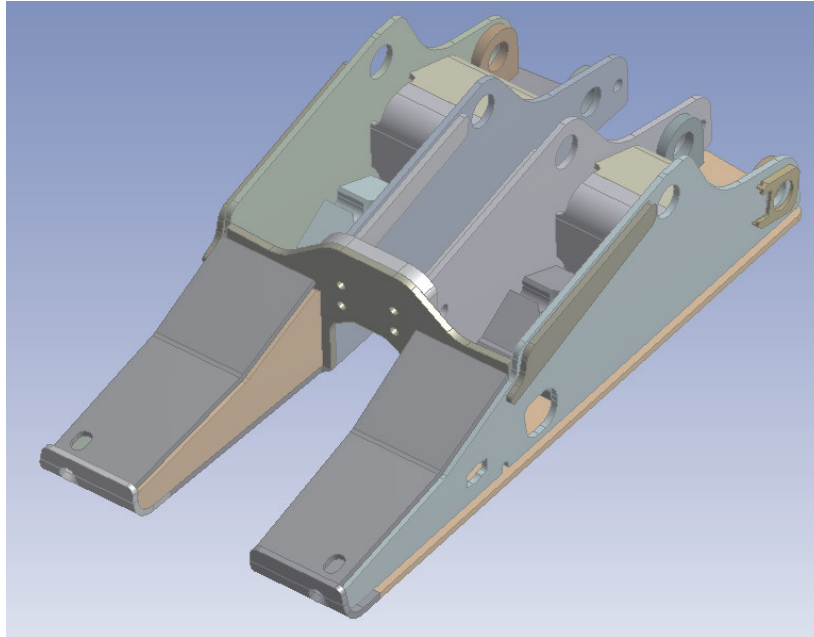

Fig. 1. Location of most frequent damages to welds in bases

Exemplary location of most frequent damages of the welds in the examined bases is presented in Figure 1, where the damage of the weld in the right part of the base is marked in red. The place of the damage and the total length of the damaged welds in the right and in the left part of the base are comparable. The most common damages were detected in the vicinity of the leg seat and along the welds that join the bottom steel plates with the side plates. The most damaged part of the base had its damaged welds of the total length of 3500 mm.

The total length of the damaged weld was assumed as a measure of the range of the damage (Jaszczuk *et al.* 2009). A histogram of the aggregate stemplot (stem and leaf display) of the total length in the bases of the 3 considered types of powered roof supports is shown in Figure 2.

The total length of damaged welds in particular components of the powered roof support is subject of change within a wide range. Depending on the roof support type, differences in the length of the damaged elements are observed.

The values of statistical parameters characterizing the data sets on the total length of the damaged welds in the bases destined for repair are compiled in Table 1.

The majority of the analyzed data sets is characterized by left sided asymmetry, and the frequency distribution concerning the occurrence of specific length of damage to the weld diverges from the normal distribution, due to random nature of factors that cause the damage. These factors include, first and foremost, the operation conditions that determine the state of load of the powered roof support,

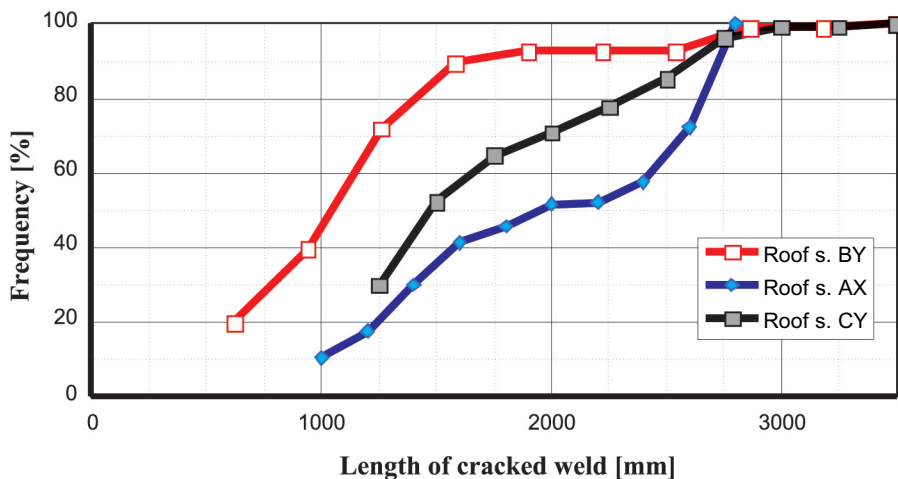

Fig. 2. Histogram of the cumulative frequency of damages to welds in bases in accordance with the types of powered roof supports

Table 1

Statistical parameters characterizing the total length of the damaged welds in the repaired powered roof support bases

	Average (mean value)	Standard deviation	Median	Dominant	Variation ratio	Skewness ratio	Typical variation range
	[mm]	[mm]	[mm]	[mm]	[%]	–	[mm]
All roof supports	1654	695	1500	1137	42	0.745	953÷2350
Roof support BY	1127	759	1100	1056	67	0.093	368÷1886
Roof support AX	1993	828	2200	2585	42	–0.352	1165÷2820
Roof support CY	1712	1104	1400	1304	65	0.644	607÷2816

factors that influence the corrosion rate, technical culture and operation time of the examined powered roof support. Also, a factor that disrupts the frequency distribution of the occurrence of specific length of welds is the fact that the bases destined for repair were in the worst technical condition in comparison with other components. In view of the above, the authors of the paper decided that the analysis of the impact of welds on the effort of the powered roof support would consider the damages of the welds the length of which is within the range of a typical variation range given in Table 1.

3. ANALYSIS OF THE EFFORT OF BASES WITH DAMAGED WELDED JOINTS

The assessment of the effort of particular components of powered roof supports was made for a three dimensional model of the support that considers both symmetrical and asymmetrical load options provided in the stand tests scheme pursuant to standard: PN-EN 1804-1. The devised

models accurately reflect the structural form of a shield powered roof support designed and manufactured by one of the leading producers of mining machinery, symbolically labeled as XY 12/24 Oz. The base of the analyzed roof support is made of three types of steel. The side and bottom plates and the two plates that constitute the bridge (Fig. 3) are made of S690QL steel. The back skin plates and the skin plates at the legseatare made of S460N steel, whereas the inner fins in the damaged front part of the base are made of S355J2 steel. To determine the impact of the length of the damaged weld on the effort of this component and on other essential components of the powered roof support, the effort of the model with well-made welds was compared with the effort of the model with a damaged weld. The damage of the weld was modeled as the absence of connection between the nodes of the model along the section in which a crack occurs.

For example, in Figure 3 a strained form of the base model is shown for symmetrical load of the powered roof support with 1170 mm fissure along the cracked weld.

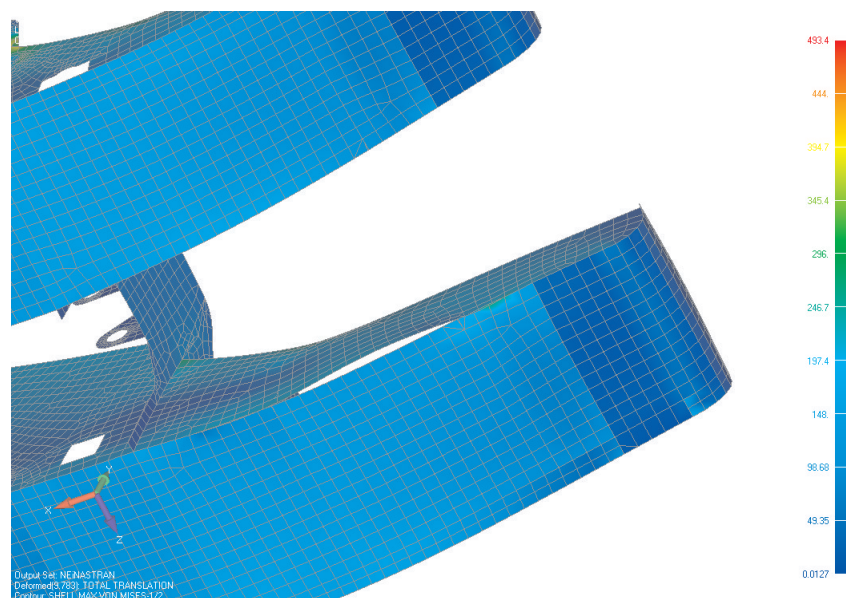

Fig. 3. Strained form of the base model containing a fissure (1170 mm) along the cracked weld for symmetrical load of the powered roof support

Changes in the maximal value of reduced stresses in particular components of the roof support evoked by an increment of the length of the crack in the weld joining the side plates with the bottom ones are presented in Figures 4 and 5 – for the section located in the front part of the base ahead of the bridge connecting its left and right part and in consideration of the material type. The analysis of the calculation results for bigger sections of the cracked weld leads to the conclusion that such damage exerts an insignificant impact on the state of effort of the base and, practically, does not influence the state of effort of the roof bar. An important increase in the effort level occurs only in the inner fins of the base made of S355J2 steel (Fig. 5b). Due to the damage of the weld joining one of the side plates with the bottom plates of the base, even for external symmetrical load of the roof support the internal fins in the front part of the base are asymmetrically loaded.

However, an insignificant impact of the length of the crack in the analyzed weld on the effort of the base concerns the weld section in the front part of the base ahead of the bridge connecting the left and right sides of the base and refers to symmetrical load.

Likewise, the cracks in welds joining the leg seat with the inner side plates were also subjected to analysis. It was assumed that the damage occurred at one side of the seat – in the joint between the seat and the inner side plates. The maximal value of reduced stresses designated for a linearly elastic model is significantly higher than the stresses value at the strength limit. Accordingly, such type of damage would lead to breaking up of the welds joining the bottom plates with the side plates for symmetrical load. Hence, further use of the base would result in the loss of the operational functionality of the powered roof support.

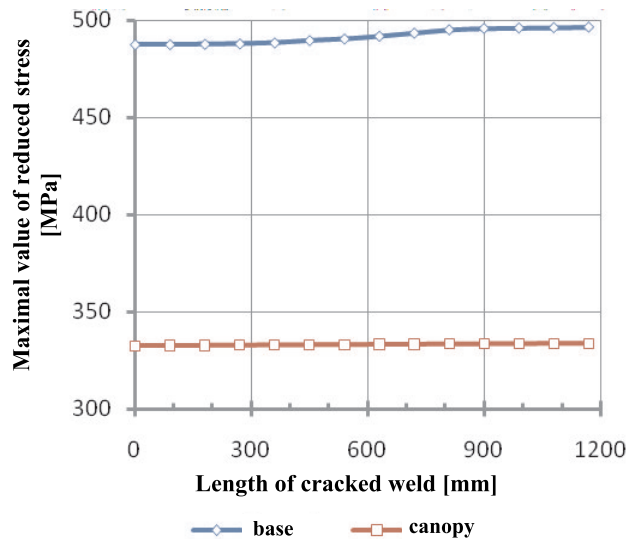

Fig. 4. Impact of the length of the cracked weld on the state of effort of the base plates and the roof-bar plates made of S690OL steel

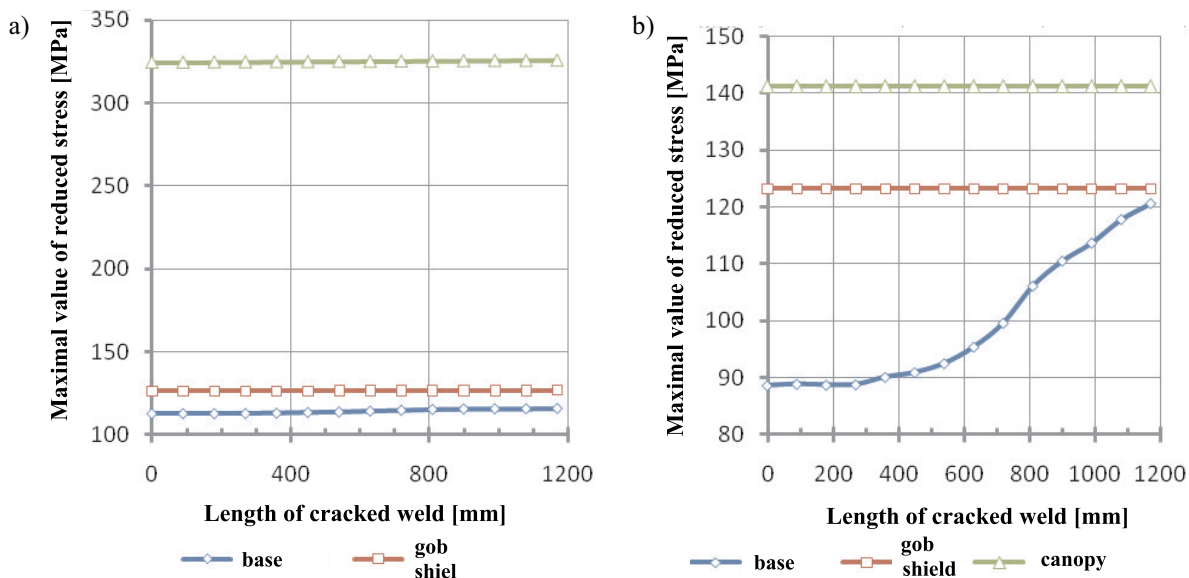

Fig. 5. Impact of the length of the crack on the effort of the plates made of S460N (a) and S355J2 (b) steel in the components of the powered roof support

To determine the impact of the asymmetry of the external load of powered roof supports on the state of effort of their bases containing damaged welds, all support options used in stand test runs pursuant to standard: PN-EN 1804-1 were taken into account. The option characterized by the highest value of reduced stresses in the base was selected for further analysis. The highest value of stresses is reached for asymmetrical load in the course of the torsion test applied to the base. The effort analysis was conducted assuming the elasticity and plasticity properties (with reinforcement) of the material from which the base elements are made.

The impact of the length of the damaged weld joining the side plates with the bottom plates along the section located in the front part of the base ahead of the bridge connecting its left and right parts is expressed as the maximal stresses in the plates of the base and of the roof bar made of S690QL steel – as shown in Figure 6. Apart from the curves presenting the change in the maximal value of reduced stresses as a function of the length of the damaged weld, the values of the stresses at the plasticity boundary R_e and at the strength

boundary R_m were marked by broken lines. Simulation of the increase in the length of the damaged weld to the value of about 570 mm does not result in significant changes in the values of reduced stresses in the base. A rapid increase in the effort of the base occurs at the crack length exceeding 570 mm. Further increase in the length of the damage results in the value of reduced stresses reaching the level of the strength limit. The change in the length of the damage to the weld in the base is not accompanied by changes in the state of effort of the plates in the roof bar (Fig. 6) as far as the plates made of S690QL steel are concerned. For the full range of the analyzed crack, reduced stresses change only insignificantly, and their maximal value is much lower than the plasticity boundary (yield point) value.

Inner fins of the base play a significant role in limiting the level of effort in the welds joining the bottom plates with the side plates. The fins reduce the possibility of the strain of the side plates. The distribution of the reduced stresses in this zone is presented in Figure 7, where a visible fissure along the cracked weld is also indicated.

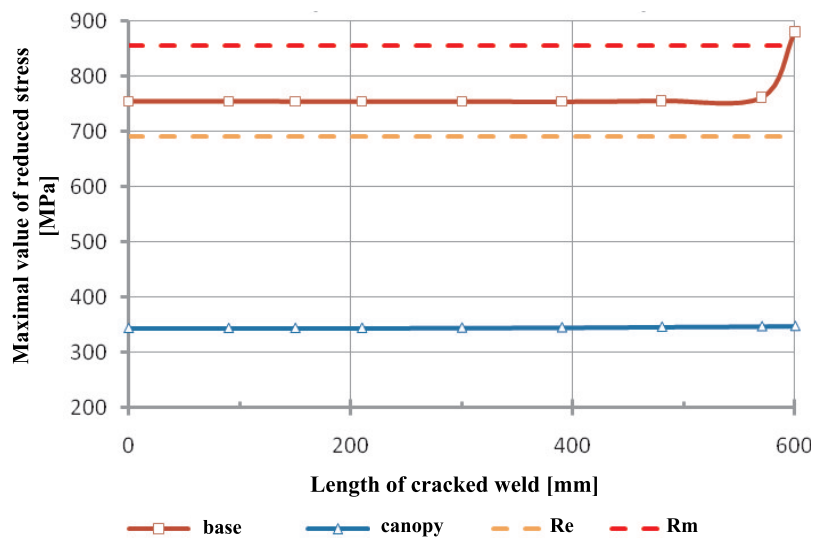

Fig. 6. Impact of the length of the damaged weld on the maximal value of reduced stress in the plates of the base and the plates of the roof bar made of S690QL steel

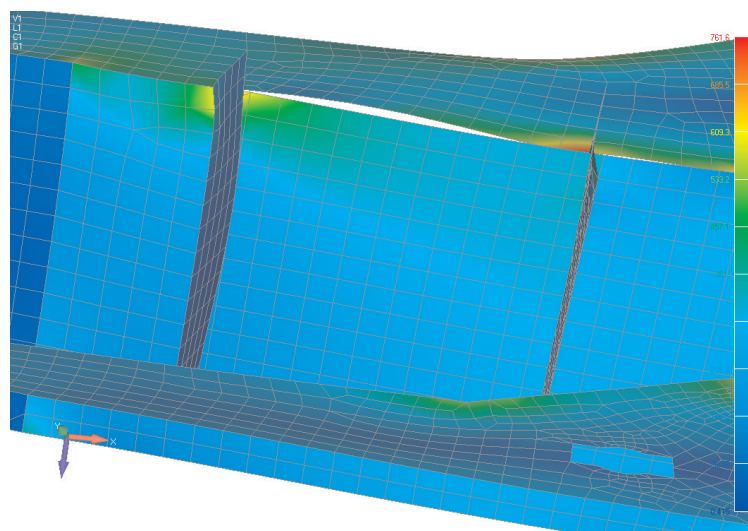

Fig. 7. Distribution of the reduced stress in the base in the zone of the damaged weld for the length of crack equal to 570 mm

4. CONCLUSIONS

Following an example of damage to welded joints detected in the course of the mining operations it was proved, by means of the finite elements method, that not every damage to the load-bearing weld in the base results in the loss of the operational safety of the powered roof support.

Although each damage to the welded joint may pose threats to the loss of the operational functionality of the equipment, after detailed analysis of given damages and the fulfillment of the conditions concerning the observation of their further propagation, it may be concluded that it is possible to avoid instant replacement of the element of the powered roof support component in the course of the long-wall run. If the maximal value of the reduced stresses is treated as a measurement of operational safety of the roof support component, it is possible- on the grounds of computer simulations – to designate the limit length of damage to the weld, after which the maximal value of the reduced stresses reaches the plasticity limit (local plasticization of a component), or the value of stresses at the strength limit (and permanent breaking up of the continuity of the weld).

On the bases of computer simulations it was indicated that the type of load has a major impact on the effort of the roof support components. In the case of symmetrical load,

the damage to the weld (provided that it is not located in the zone of the leg seat in the base) results in lowered value of the maximal reduced stresses in comparison with the plasticity limit (yield point) even when the weld is damaged at the length of 1000 mm. In the case of asymmetrical load entailing bigger effort of the base, the maximal value of the reduced stresses will reach the level at the plasticity limit (yield point) even for the damage length of 570 mm. In view of a complex nature of the state of stresses in the powered roof components, each of the observed cases requires individual measures, in consideration of the asymmetrical model of the load evoking the maximal effort of the material in the base.

For safety reasons, the decision on further operation of a components containing damaged welds should be preceded by the analysis of the state of effort of the powered roof support under asymmetrical load.

References

- Jaszczuk M., Szweda S., Markowicz J. 2009, *Analysis of damage to welds of the components of powered roof supports in view of the data acquisition required for material strength calculations*. [in:] Mining Mechanization and Automation, No. 4, pp. 19–24.
- PN-EN 1804-1 *Underground mining machinery. Safety requirements for powered roof supports. Section 1: Powered roof support components and general requirements*.